

LOW NOISE / HIGH STABILITY I TO V CONVERTER SP 983C (WITH INTERNAL OFFSET SUBTRACTION) WITH LSK389A

DATASHEET VERSION 2.2

JUNE 2018

FEATURES

- Low input voltage noise
 → Typical input referred voltage noise:
 4.5 nV/sqrt(Hz) @ 10 Hz
 1.9 nV/sqrt(Hz) @ 1 kHz
- Stable and low drift input voltage
 → Typical input voltage drift @25°C:
 ±0.15 μV/K
- Typical input current noise level:
 → 5 fA/sqrt(Hz) @10 Hz, 10⁹ V/A
- Five decades of gain: 10⁵...10⁹ V/A
- Broadband (e.g. min. 20 kHz @ 10⁸ V/A)
- Integrated low-pass-filter: 30 Hz...100 kHz
- Remote controllable gain and LP-cutoff
- Input voltage can be shifted up to ±100 mV by an external offset voltage
- The input offset voltage is internally subtracted (new in version SP 983c)
- Green LED indicates when input offset voltage is compensated and stable
- Red LED indicates overloaded condition
- SMA input & output connectors / BNC-adapters included
- Overload protected current input
- Small size, low weight

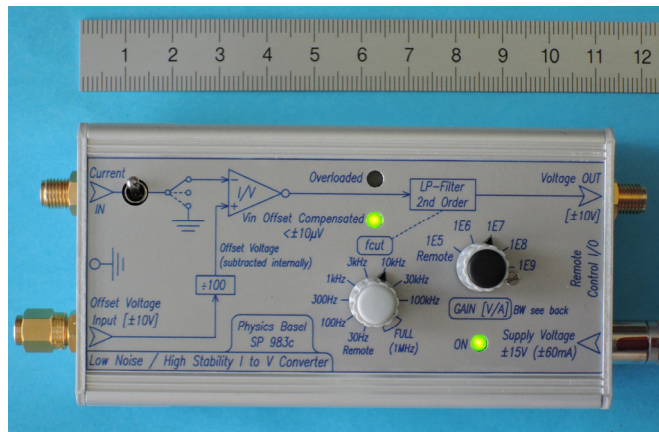

APPLICATIONS

- Current measurements on sensitive samples at cryogenic temperatures
- Preamplifier for scanning tunneling microscopes (STM)
- Low level light detection with photodiodes or photomultipliers

1. OVERVIEW

This *Low Noise / High Stability I to V Converter (LNHS I/V Converter)* combines a very low input voltage noise with a high stability and low drift input voltage. Low input voltage noise is reached by using a discrete dual J-FET input stage. The offset voltage drift of this dual J-FET input stage is reduced by using a high stability input offset correction circuit. The block diagram of the *LNHS I/V Converter* is shown below:

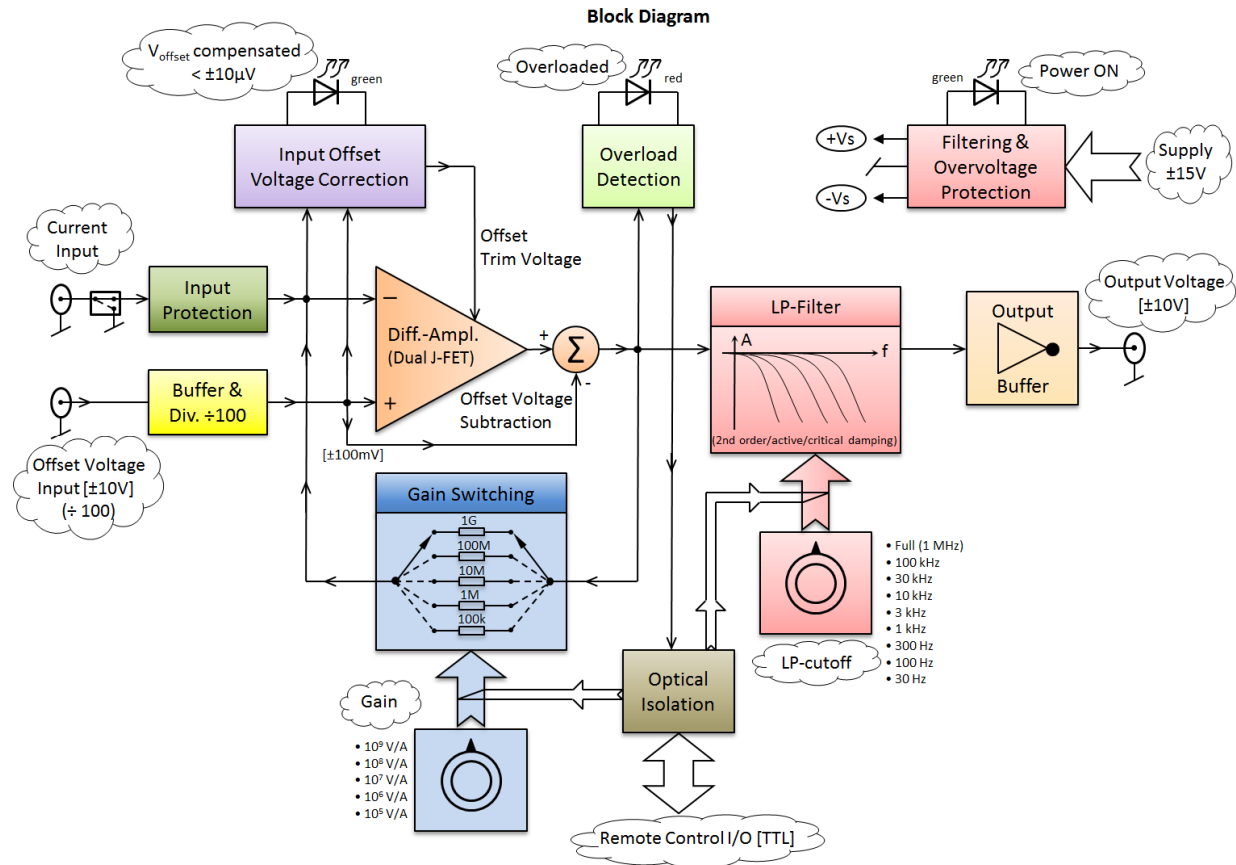

The light weight and small housing of the *LNHS I/V Converter* permits the installation of this device directly onto the breakout box of the cryostat, or very close to it. Doing so, the cumbersome and sensitive cables (noise pick-up, microphonics) between the cryostat and the preamplifier can be avoided. Since the gain as well as the low-pass cutoff frequency can be remotely controlled (e.g. by a computer) the *LNHS I/V Converter* can be installed in a not readily accessible place. The remote control signals are galvanic isolated by optocouplers and therefore they do not interfere with the sensitive input signals and no ground loop can be formed.

2. INPUT OFFSET VOLTAGE

To improve the stability and temperature drift of the discrete dual J-FET (LSK389A) a high precision servo control loop cancels out the input offset voltage and its drift due to changes in temperature. At around 25°C this compensation circuit reaches a typical temperature drift of the input offset voltage of only $\pm 0.15 \mu\text{V/K}$ (max. $\pm 1 \mu\text{V/K}$).

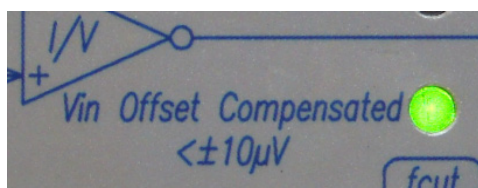

The green LED *Vin Offset Compensated* lights up when the input offset voltage is stabilized within around $\pm 10 \mu\text{V}$ with respect to the user defined input voltage (up to $\pm 100 \text{ mV}$ given by *Offset Voltage Input*). After power up the device it may take several minutes (up to 10 minutes) until the automatic input offset compensation is completed and the green LED is turned on.

Applying a changing voltage to the *Offset Voltage Input* does not kill the successful input offset compensation and the green LED stays on permanently even if the offset input voltage is rapidly switched from typical +8 V to -8 V. If the device is overloaded (indicated by the red LED *Overloaded*) the input offset compensation may be killed and when the output is back in the linear range the compensation will automatically restart.

Each *LNHS I/V Converter* has its own “fixed” input offset voltage error, which is specific for this device. At room temperature and the *Offset Voltage Input* left open or grounded, this “fixed” input offset voltage error lays within a range from typical -30 μV to +30 μV (maximum $\pm 150 \mu\text{V}$). For example if a device has a “fixed” input offset voltage error of -11 μV the green LED *Vin Offset Compensated* gets activated if the input offset voltage is compensated within a range of around -21 μV to -1 μV . Around 15 seconds after the green LED *Vin Offset Compensated* is turned on the “fixed” input offset voltage (e.g. -11 μV) is reached.

If a certain measurement needs an input offset voltage of exactly zero, the “fixed” input offset voltage can be canceled by a small and stable DC-voltage applied to the *Offset Voltage Input*. This input voltage is divided by 100 and it has an input resistance of 10 k Ω . To zero a “fixed” input offset voltage of -11 μV (from the example before) a DC-voltage of +1.1 mV has to be applied to the *Offset Voltage Input*. The input offset voltage can directly be measured by using a high precision microvolt-meter connected to the current input of the *LNHS I/V Converter*. For such measurements thermoelectric voltages coming from the interconnections can cause troubles. Therefore use short and good cables (gold contacts) and wait until the setup has reached its thermal equilibrium (takes several minutes) before starting the DC input offset voltage measurement.

By using the *Offset Voltage Input* the input reference voltage of the I/V converter can be shifted and thereby also the voltage across the sample can be altered. A positive *Offset Voltage Input* leads to hundred times smaller positive input reference voltage; e.g. +3 V at *Offset Voltage Input* \rightarrow +30 mV at the input of the I/V converter. This input offset voltage is internally subtracted and is not on top of the output voltage of the *LNHS I/V Converter*; this feature is new in version SP 983c. The suppression of the input offset voltage with respect to output voltage is typical 60 dB.

For lock-in measurements AC-signals up to a frequency of 10 kHz (-3 dB) can also be applied to the *Offset Voltage Input*. Be aware that capacitances at the input of the I/V converter (from cabling and filtering) will lead to a significant AC-signal at the output (90° phase shifted); especially when using higher frequencies.

3. INPUT VOLTAGE NOISE

For current measurements on very cold samples (near 0 K) it is crucial that the input voltage noise of the used I/V converter is small. This is because the noise voltage is applied directly or LP-filtered (typical by cryogenic LP-filters) to the sample. The noise voltage leads to thermal power dissipation on the nano-structures and it also randomly shifts the voltage across the sample. At a fixed sample resistance the thermal power dissipation scales with the square of the integrated noise voltage. Therefore a low input voltage noise density of the I/V converter is required, specially a lower frequencies. For long term measurements also low temperatures drift of the input voltage is necessary. Since the *LNHS I/V Converter* combines these two features it is very suitable for such measurements on samples at temperature near the absolute zero.

The figure below shows the simplified schematic of an I/V converter loaded at the input with a capacitance (C_{in}). Each of the input J-FET has its own and independent voltage noise source named as $Un-$ and $Un+$ which build the total voltage noise (Un_{tot}) by statically summing.

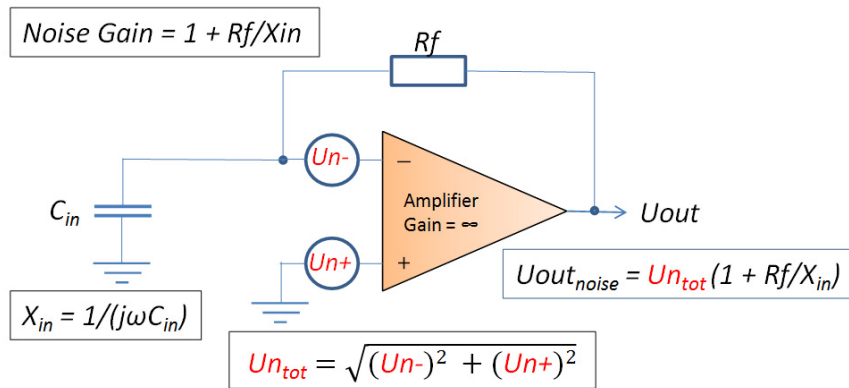

When loading an I/V converter at its input with the impedance (X_{in}) the total input voltage noise (Un_{tot}) is amplified by the *Noise Gain* = $1 + Rf/X_{in}$. Herby the assumption is made that the differential amplifier has an infinite voltage gain.

For small input impedances (X_{in}), compared to the feedback resistor (Rf), the total input voltage noise (Un_{tot}) multiplied by the *Noise Gain* can be the dominant noise source; particularly when measuring with a “normal” I/V converter, which has around five to ten times higher input voltage noise compared to the *LNHS I/V Converter*. When loading the input of an I/V convert with a capacitor (C_{in}), coming from cables and filters, the output noise increases in function of frequency. This is due to the fact that the impedance of a capacitor decreases with frequency ($\omega = 2\pi f$): $X_{in} = 1/(j\omega C_{in})$

Then the output noise increases linearly with frequency: $Uout_{noise} = Un_{tot}(1 + j\omega Rf C_{in})$

Since the bandwidth of real amplifier is limited, at a certain frequency the noise is no longer increasing and it starts to decrease with frequency. When measuring the output noise with a spectrum analyzer then the frequency-plot shows a “noise-peaking” at a certain frequency. The exact frequency of this “noise-peaking” is depending on the input capacitance (C_{in}), the selected gain (Rf) and the gain bandwidth product (*GBWP*) of the differential amplifier. In almost all setups a capacitance at the input of the I/V converter cannot be avoided and some “noise-peaking” will occur; the lower the input capacitance the smaller the “noise-peaking”. Filtering this “noise-peaking” by the build in low-pass-filter prevents from overloading the subsequent instruments (e.g. lock-in amplifier).

The input voltage noise is independent on the selected gain of the I/V converter, but on the frequency. This is due to the $1/f$ noise generated by the J-FET input stage. The following typical total input voltage noise densities (Un_{tot}) can be measured at room temperature:

| @ f = 10 Hz | @ f = 30 Hz | @ f = 100 Hz | @ f = 1 kHz |
|-----------------|-----------------|-----------------|-----------------|
| 4.5 nV/sqrt(Hz) | 2.7 nV/sqrt(Hz) | 2.2 nV/sqrt(Hz) | 1.9 nV/sqrt(Hz) |

The integrated total input noise voltage from 0.5 Hz to 1 kHz is typically 84 nV_{RMS}. This input voltage noise is seen by the sample connected to the input of the *LNHS I/V Converter*. Above 1 kHz a total input voltage noise density of 1.9 nV/sqrt(Hz) can be assumed.

Supposing that the two J-FETs of the LSK389A (monolithic dual) in the input stage have the same voltage noise ($Un- = Un+$), the voltage noise per J-FET is then Un_{tot} divided by square root of two. This leads to the following typical input voltage noise densities ($Un- = Un+$) per J-FET at room temperature:

| @ f = 10 Hz | @ f = 30 Hz | @ f = 100 Hz | @ f = 1 kHz |
|-----------------|-----------------|-----------------|------------------|
| 3.2 nV/sqrt(Hz) | 1.9 nV/sqrt(Hz) | 1.6 nV/sqrt(Hz) | 1.35 nV/sqrt(Hz) |

These values correspond well with the numbers given in the datasheet of the LSK389A from *Linear Systems*. The following input voltage noise densities are specified in the datasheet:

@f = 10 Hz → typical 2.5 nV/sqrt(Hz), maximum 4 nV/sqrt(Hz) @f = 1 kHz → typical 0.9 nV/sqrt(Hz), maximum 1.9 nV/sqrt(Hz)

4. INPUT CURRENT NOISE

The input current noise of the *LNHS I/V Converter* is dependent on the gain. It is dominated by the thermal noise of the feedback resistor (R_f). Since the current noise scales with the square root of the gain, the signal/noise-ratio increases also with the square root of the gain. Therefore the highest possible gain should be selected when measuring with I/V converters. The theoretical limit of the current noise density is calculated by the thermal noise of the feedback resistor at room temperature (300 K).

The following typical input current noise densities are measured at room temperature when the current input is left open (noting connected) and shielded against stray pick-up:

| GAIN [V/A] | Current Noise @ 10 Hz [fA/sqrt(Hz)] | Current Noise @ 1 kHz [fA/sqrt(Hz)] | Theoretical Limit [fA/sqrt(Hz)] |
|------------|-------------------------------------|-------------------------------------|---------------------------------|
| 10^9 | 5 | 8 | 4.1 |
| 10^8 | 13.7 | 15 | 13 |
| 10^7 | 42 | 42.5 | 41 |
| 10^6 | 139 | 139 | 130 |
| 10^5 | 590 | 580 | 410 |

The slightly increased input current noise density in the 10^5 V/A range comes from the noise-contribution of the active low-pass-filter after the I/V converter stage.

5. SELECTORS, INDICATORS & I/O CONNECTORS, SIZE

Below the selectors, the LED indicators and the I/O connectors of the *LNHS I/V Converter* are shown:

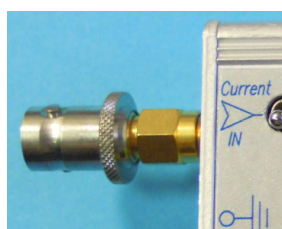
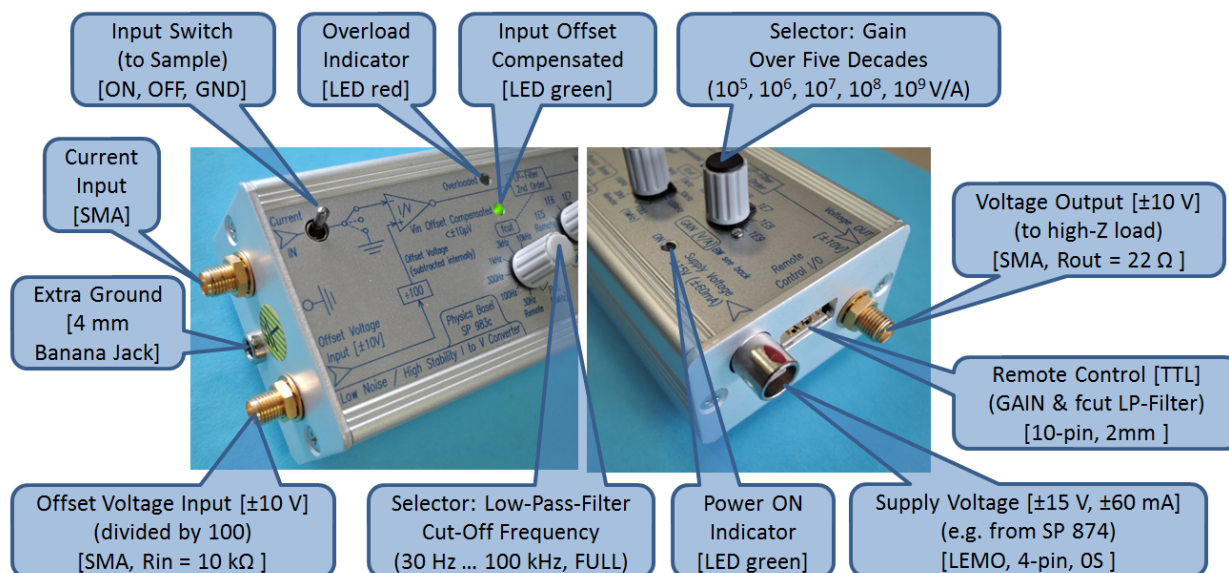

All the analog I/O signals are connected by SMA connectors to the device. If BNC connectors are preferred stable SMA/BNC-adapters can be screwed directly onto the *LNHS I/V Converter* (see left).

The gain and the cut-off frequency of the low-pass filter can be manually selected by two rotary switches. For remote control the two rotary switches have to be at their most counter-clockwise position.

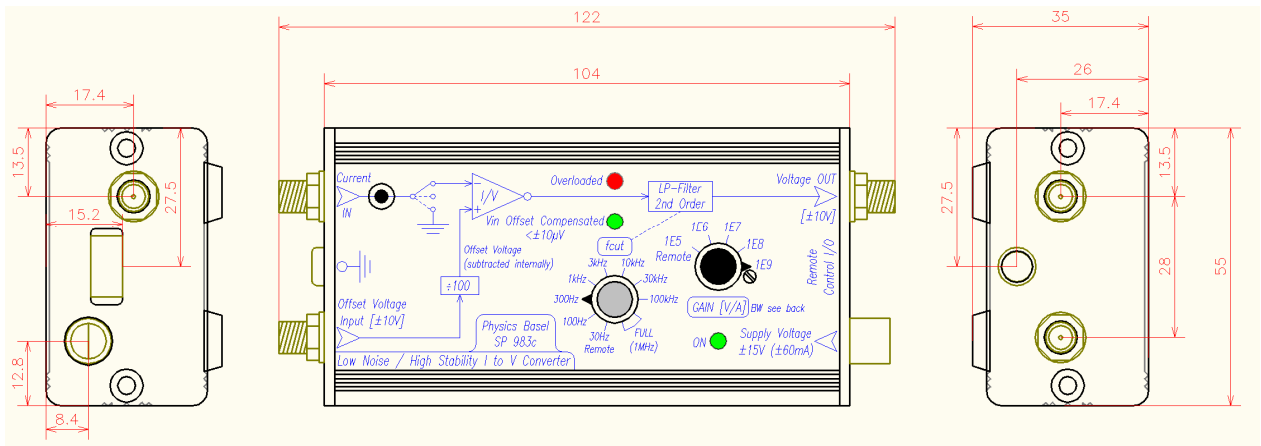

The size [mm] and position of the connectors are shown above. The weight of the device is only 165 g.

6. CURRENT INPUT

The current input of the *LNHS I/V Converter* has a three position toggle switch which allows connecting the sample to ground, open or to the input of the I/V converter.

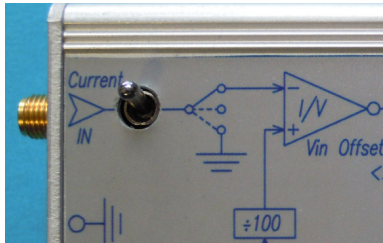

Grounding sensitive samples by using this input switch is strongly recommended during manipulations on the I/V converter (e.g. changing gain, power on/off).

When using this toggle switch, the input of the I/V converter itself is not grounded and therefore no overload condition occurs. When the sample and the input of the I/V converter is grounded (e.g. by an external switch) the output of the I/V converter goes immediately to the positive or negative supply voltage. This is due to the “fixed” input offset voltage which is amplified by the tremendous DC-gain when an I/V converter is grounded at its input. At the moment when the grounding of the sample is released the I/V converter has first to recover from its overload condition. This may last for several milliseconds and inject a large amount of charge to the sample, which may destroy it.

The current input of the *LNHS I/V Converter* is protected against overcurrent. Nevertheless be careful what you connected to this sensitive input. Do not touch this input with your fingers or any objects, since electrostatic discharge may damage the sensitive input J-FET. The typical input offset current is ± 3 pA.

The DC input resistance of the *LNHS I/V Converter* is dominated by the input protection circuit, which has a resistance of around 33Ω (R_{prot}).

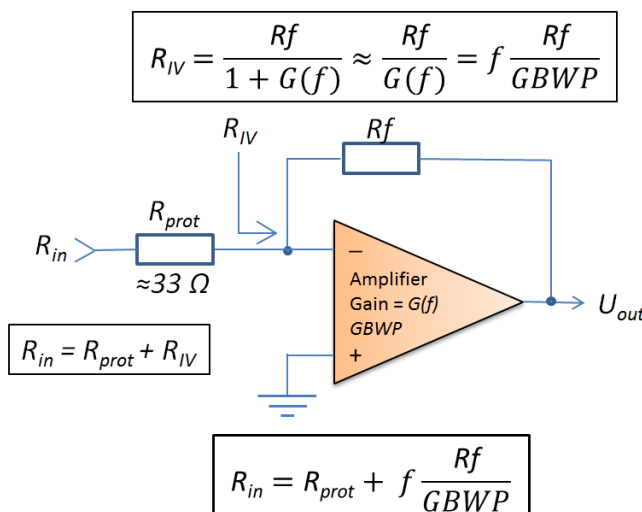

For AC signals the input resistance (R_{in}) is increased by the virtual input impedance (R_{IV}) of the I/V converter which is depended on the frequency (f), the feedback-resistor ($R_f = \text{gain}$) and the gain bandwidth product ($GBWP$) of the amplifier (see left). The $GBWP$ of the *LNHS I/V Converter* is about 68 MHz.

Example of calculating the AC-input resistance:

$f = 1 \text{ kHz}$
 $\text{Gain} = 10^7 \text{ V/A}$
 $GBWP = 68 \text{ MHz}$
 $R_{prot} = 33 \Omega$

$R_{in} = 33 \Omega + 1 \text{ kHz} * (1E7 / 68E6) = \underline{180 \Omega}$

7. GAIN & OUTPUT



The gain of the *LNHS I/V Converter* can be switched over five decades from 10^5 to 10^9 V/A (1E5...1E9) which cover the most often used gains in cryogenic experiments. A gain of 10^5 V/A corresponds to a feedback resistor (R_f) of 100 k Ω and for a gain of 10^9 V/A a 1 G Ω resistor is used in the feedback of the I/V converter. Since the downstream LP-filter and the output buffer have no additional gain the current noise performance is mainly given by the feedback resistor of the I/V converter. The accuracy of the gain is typical $\pm 0.5\%$ (maximum $\pm 2\%$).

A positive input current (flowing into the I/V converter) results in a positive output voltage. The output voltage has an impedance of 22 Ohm and must be connected to high impedance (≥ 10 k Ω) load. The output voltage swing is linearly within a voltage of ± 10 V. When the output voltage of the I/V converter reaches or exceeds +9.5 V or -9.5 V the red LED *Overloaded* is turned on.

Note that the overload is detected on the unfiltered output voltage of the I/V converter stage. While measuring AC-signals (e.g. with a lock-in) and the LP-filter set to the lower frequency range, the output voltage may still be in its linear range (± 10 V) while an overload is detected at the I/V converter stage – that’s why you should pay attention to the *Overloaded* LED during experiments using AC-signals. The overload information is also available (galvanic isolated) on the *Remote Control I/O* connector.

8. RISE/FALL-TIME & BANDWIDTH

The maximum bandwidth of the *LNHS I/V Converter* is dependent on the selected gain. Higher gains lead to higher rise/fall-times and lower bandwidths. The following table shows the typical step-response rise/fall-time (10%, 90%) and the typical bandwidth (-3 dB) for small signals (< 1 V_{RMS}) at room temperature; the low-pass-filter cutoff frequency is set to its maximum (“FULL”, 1 MHz):

| GAIN [V/A] | Rise/Fall-Time (10%, 90%) [μ s] typical maximum | Bandwidth (-3 dB) @ 1 V [kHz] typical minimum |
|------------|-----------------------------------------------------------|----------------------------------------------------|
| 10^9 | 204 270 | 1.6 1.2 |
| 10^8 | 13 15 | 26 20 |
| 10^7 | 3.5 3.7 | 93 90 |
| 10^6 | 1.1 1.2 | 305 300 |
| 10^5 | 0.58 0.62 | 590 500 |

9. LOW-PASS-FILTER

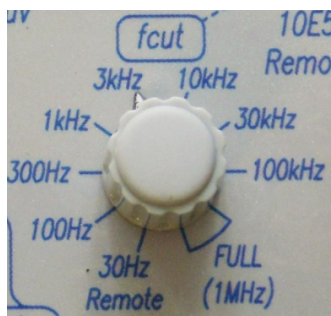

The maximum bandwidth of the I/V converter can be reduced by the subsequent low-pass-filter (LP-filter). The cut-off frequency (-3 dB) of the LP-filter can be selected from 30 Hz up to 100 kHz within eight steps (see left). The accuracy of the cut-off frequency (f_{cut}) is within $\pm 20\%$. At the two positions “FULL” the bandwidth of the filter is around 1 MHz. The LP-filter is 2nd order (-40 dB/decade), has a gain of one and is designed with a critical damping, which results in no overshoot in the time step-response. The maximum damping of this filter is limited to around 70 dB and the noise floor density is around 25 nV/sqrt(Hz) at 1 kHz.

By using this integrated LP-filter the “noise-peaking” (when the input of the I/V converter is capacitive-loaded) can efficiently be reduced (see also chapter 3. *Input Voltage Noise*).

The following plot shows the measured frequency response with small signals ($<1 V_{RMS}$) at a gain of $10^5 V/A$ and with the nine different LP-filter cut-off frequencies. Since the bandwidth in the $10^5 V/A$ range is limited to 500 kHz the 1 MHz bandwidth of the LP-filter in the position “FULL” cannot be identified.

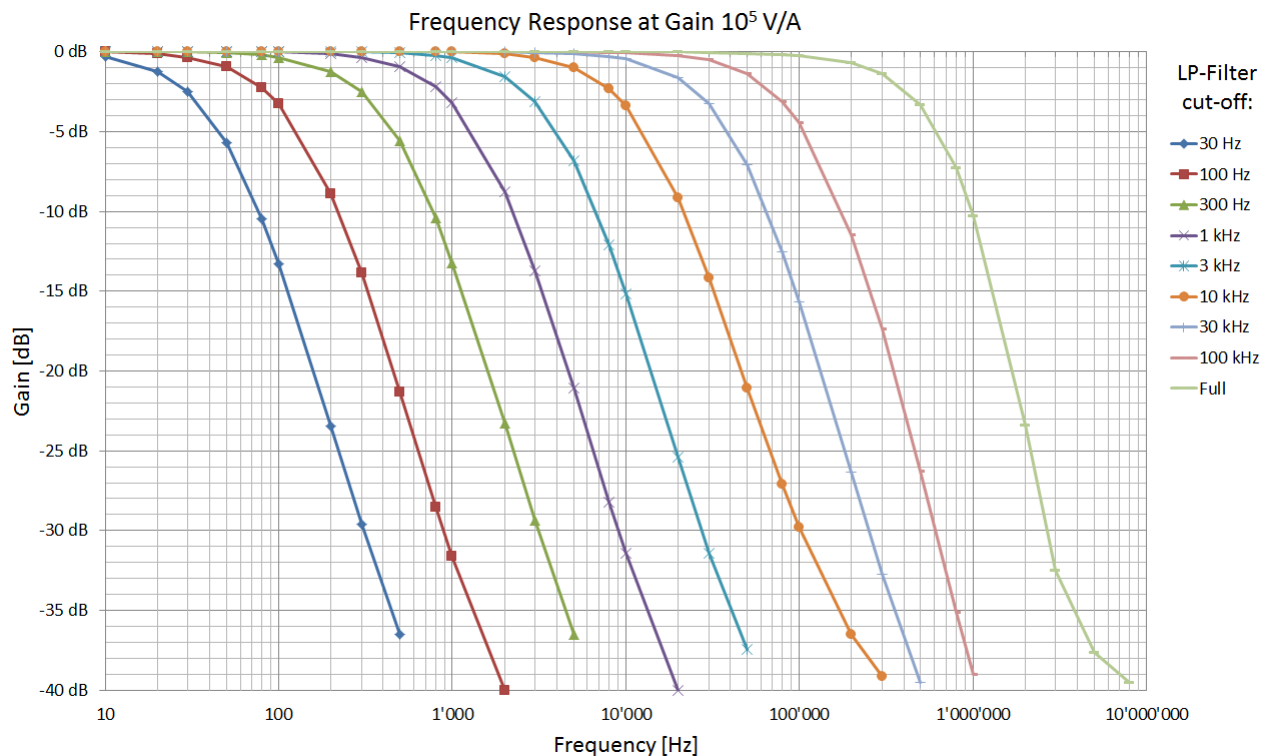

The table below shows the typical step-response rise/fall-times (10%, 90%) of the LP-filter for the different cut-off frequencies. Note that the LP-filter cut-off frequencies (f_{cut}) have a tolerance of up to $\pm 20\%$ and therefore also the rise/fall-times can vary up to $\pm 20\%$.

| $f_{cut} =$ | 30 Hz | 100 Hz | 300 Hz | 1 kHz | 3 kHz | 10 kHz | 30 kHz | 100 kHz | Full |
|---------------|---------|---------|---------|-------------|-------------|--------------|--------------|--------------|--------|
| $t_r / t_f =$ | 11.5 ms | 3.44 ms | 1.15 ms | 344 μs | 115 μs | 34.4 μs | 11.5 μs | 3.44 μs | 340 ns |

10. SUPPLY VOLTAGE

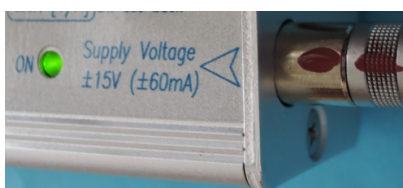

The supply voltage of the *LNHS I/V Converter* is $\pm 15 V$ with a tolerance of $\pm 5 \%$. The green LED “ON” lights up when the supply voltage reaches $\pm 13.5 V$ (see left). The typical quiescent current is around $\pm 40 mA$, but it can rise to $\pm 60 mA$ during normal working conditions. **It is very important that the *LNHS I/V Converter* is supplied by a floating, low noise, low ripple and stable voltage source.**

Only when using a high-quality and low noise power supply the outstanding noise performance and the high stability input voltage can be reached. Linear regulated laboratory power supplies (e.g. *TOELLNER 8735*), our *Floating Supply $\pm 15 V$ (SP 874)* or $\pm 15 V$ batteries/accumulators are suitable for supplying the *LNHS I/V Converter*.

The ground (0 V) of the power supply must be floating and the earth leakage current should be less than $2 \mu A_{RMS}$. Inside the *LNHS I/V Converter* the ground (0 V) of the power supply is connected to the housing and therefore also to the shield of the power supply socket. To prevent from noise pick-up on the long cable to the power supply, use a shielded one and connect the shield only at the socket of the *LNHS I/V Converter*.

The connector for the ± 15 V supply voltage is a 4-pole *LEMO* series *05* with the following part number: *FFA.05.304.(CLAC44)*

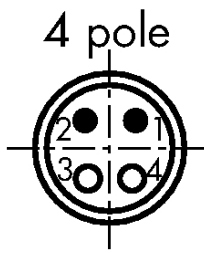

The pin assignment of the power connector is the following:

- PIN 1: +15 V / +60 mA
- PIN 2: -15 V / -60 mA
- PIN 3: not connected
- PIN 4: 0 V / Ground
(Shield is connected to housing and 0 V)

11. REMOTE CONTROL

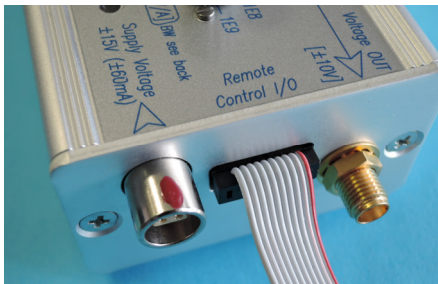

Via the remote control I/O connector (see left) the gain and the LP-filter cut-off frequency can be controlled by an external source (e.g. computer). The remote control signals are galvanically isolated with optocouplers from the electronics of the *LNHS I/V Converter*. Therefore no ground-loops or interference can occur by using these remote control lines. Nevertheless, make sure that the TTL control signals are clean and do not carry any high-frequency noise. High-frequency noise may capacitive coupling into the sensitive electronics of the I/V converter. If this is observed, low-pass filtering of the TTL control signals, before entering the device, may be necessary.



When the gain is remote controlled the rotary switch “GAIN” has to be in the position “1E5, Remote”. For remote controlling the LP-filter cut-off frequency the rotary switch “fcut” must be set to the position “30Hz, Remote” (see left). It is possible to control only the gain or only the cut-off frequency remotely and manually set the other by the rotary switch.

A 10-pole flat cable connector *Minitek 2x5P* (type *89947-710LF*) fits into the socket of the *Remote Control I/O*. In low-interference laboratory environment an unshielded flat cable up to a length of around five meters can be connected between the *LNHS I/V Converter* and a computer. The assignment of the remote control connector is the following:

| PIN 1 | PIN 2 | PIN 3 | PIN 4 | PIN 5 | PIN 6 | PIN 7 | PIN 8 | PIN 9 | PIN 10 |
|-------|-------|-------|-------|-------|-------|-------|-------|-------|--------|
| G0 | F0 | G1 | F1 | G2 | F2 | COM | F3 | OVL C | OVL E |

G0...G2 is for the gain selection and F0...F3 for setting the LP-filter cut-off frequency. COM is the common ground (0V of the computer) for the gain and filter remote TTL control signals. A logic high (1) needs a voltage larger than +2.5 V and a logic low (0) a voltage smaller than +0.8 V; the remote control inputs are therefore compatible with 3.3 V logic output levels. Each remote control input signals is loaded by a 1.8 k Ω resistor to the common ground (COM). Do not apply voltages higher than +7 V and no negative voltages to these remote control inputs.

The OVL C and the OVL E pins is the collector (C) and the emitter (E) of the outputs NPN-transistor (optocoupler), which closes when an overload condition is detected (red LED *Overloaded*). A maximum voltage of 30 V and a maximum current of 20 mA can be switched by this transistor. The positive voltage must be connected to the collector (C) and the external ground to the emitter (E). This enables reading the overload condition (e.g. by a computer) or externally indicate it by a LED or buzzer.

Below the table for remote setting the gain is given:

| GAIN [V/A] | G2 (PIN 5) | G1 (PIN 3) | G0 (PIN 1) |
|-----------------|------------|------------|------------|
| 10 ⁹ | 1 | 0 | 0 |
| 10 ⁸ | 0 | 1 | 1 |
| 10 ⁷ | 0 | 1 | 0 |
| 10 ⁶ | 0 | 0 | 1 |
| 10 ⁵ | 0 | 0 | 0 |

1 = logic high >2.5V / 0 = logic low <0.8V (with respect to COM)

The typical turn ON time of the gain-switching is 50 µs and the turn OFF time is 80 µs. This results in a “make before break” gain-switching behavior and no “open = undefined” feedback of the I/V converter is possible when switching the gain fast by a remote computer.

The LP-filter cut-off frequency is remote controlled by the following combinations:

| LP-Filter cut-off | F3 (PIN 8) | F2 (PIN 6) | F1 (PIN 4) | F0 (PIN 2) |
|-------------------|------------|------------|------------|------------|
| FULL, 1 MHz | 1 | 0 | 0 | 0 |
| 100 kHz | 0 | 1 | 1 | 1 |
| 30 kHz | 0 | 1 | 1 | 0 |
| 10 kHz | 0 | 1 | 0 | 1 |
| 3 kHz | 0 | 1 | 0 | 0 |
| 1 kHz | 0 | 0 | 1 | 1 |
| 300 Hz | 0 | 0 | 1 | 0 |
| 100 Hz | 0 | 0 | 0 | 1 |
| 30 Hz | 0 | 0 | 0 | 0 |

1 = logic high >2.5V / 0 = logic low <0.8V (with respect to COM)

12. TYPICAL SPECIFICATIONS (AMBIENT TEMPERATURE = 25° C)

- **Warm-up time:** 2 hours
- **Environment:** In house dry laboratory conditions, no bedewing
- **Operating temperature:** +10°C...+45°C

- **Supply voltage:** ±15 V, ±5%, low noise, high stability
- **Supply current:** ±40 mA (max. ±60 mA)
- **Green LED ON turned on:** When supply voltage > ±13.5 V

- **Gain [V/A], Minimum Bandwidth [kHz]:** 10⁵, 500 | 10⁶, 300 | 10⁷, 90 | 10⁸, 20 | 10⁹, 1.2
- **Gain accuracy:** ±0.5% (maximum ±2 %)

- **Output voltage swing:** min. ±10 V @ 10 kΩ
- **Output impedance:** 22 Ω
- **Output polarity:** Positive output voltage for a positive input current (flowing into the I/V converter)
- **Red LED *Overloaded* turned on:** When output voltage > +9.5 V or < -9.5 V:

- **External offset voltage input:** ±10 V (divided by 100) → ±100 mV (accuracy ±2 %)
- **External offset voltage input impedance:** 10 kΩ (±0.2%)
- **External offset voltage input bandwidth:** 10 kHz
- **External offset voltage suppression at the output:** 60 dB
- **External offset voltage jump with green LED *Offset Compensated ON*:** typ. ±8 V (min. ±3 V)

- **LP-filter cut-off frequency:** 30 Hz, 100 Hz, 300 Hz, 1 kHz, 3 kHz, 10 kHz, 30 kHz, 100 kHz, FULL = 1 MHz
- **LP-filter cut-off frequency accuracy:** ±20%
- **LP-filter characteristics:** 2nd order, critical damping (no overshoot), 70 dB maximum damping
- **LP-filter voltage noise floor:** 25 nV/sqrt(Hz) @ 1 kHz

- **Input voltage noise [nV/sqrt(Hz)]:** 4.5 @ 10 Hz | 2.7 @ 30 Hz | 2.2 @ 100 Hz | 1.9 @ 1 kHz
- **Integrated input voltage noise from 0.5 Hz to 1 kHz:** 84 nV_{RMS}
- **Input current noise:** 5 fA/sqrt(Hz) @ 10 Hz, gain = 10⁹ V/A
- **Input offset current:** ±3 pA

- **“Fixed” input offset voltage:** -30 μV to +30 μV (maximum ±150 μV)
- **“Fixed” input offset voltage temperature drift @25°C:** ±0.15 μV/K (max. ±1 μV/K)
- **Green LED *Offset Compensated* turned on:** When input offset voltage = “Fixed” ±10 μV

- **DC input resistance:** 33 Ω
- **Gain bandwidth product (GBWP) of amplifier:** 68 MHz

- **Remote control signals:** Positive TTL, High-level > 2.5 V, Low-level <0.8 V
- **Remote control input impedance:** 1.8 kΩ
- **Remote control gain turn ON/OFF time:** 50 μs / 80 μs (make before break)

- **Overall size** (no adapters and no cables): 122 mm x 55 mm x 35 mm
- **Weight** (no adapters and no cables): 165 g